



Accessory Name - LEGACY EDITION BACKREST WITH RAC

Model – BSA GOLDSTAR 650

Genuine Motorcycle Accessory Fitment Instructions

WARNING: BSA genuine accessories are designed to fit only the specific BSA motorcycle(s) that are specified above. They should not be fitted to any other type of motorcycle. Pay particular attention to the warnings & cautions contained in this instruction. Failure to do so may result in an incorrect installation of the accessory which could result in an unsafe riding condition and possible accident. If any doubt always seek help from your authorised BSA dealer.

WARNING: Before starting any accessory kit installation ensure the motorcycle is supported in a stable condition. Failure to support the motorcycle correctly could lead to motorcycle damage or personal injury.

WARNING: All fixings must be tightened to the torque values specified in this instruction. Failure to tighten fixings to correct torque could result in an unsafe riding condition and possible accident

CAUTION: Care should be taken when fitting any accessory kit. Incorrect handling of kit components or the use of incorrect tools could lead to component or motorcycle damage.

NOTE: The content of this instruction is subject to change at any time without notice or liability. BSA reserves the right to revise the information presented at any time.

T14000B10550N-LEGACY EDITION BACK REST WITH RACK

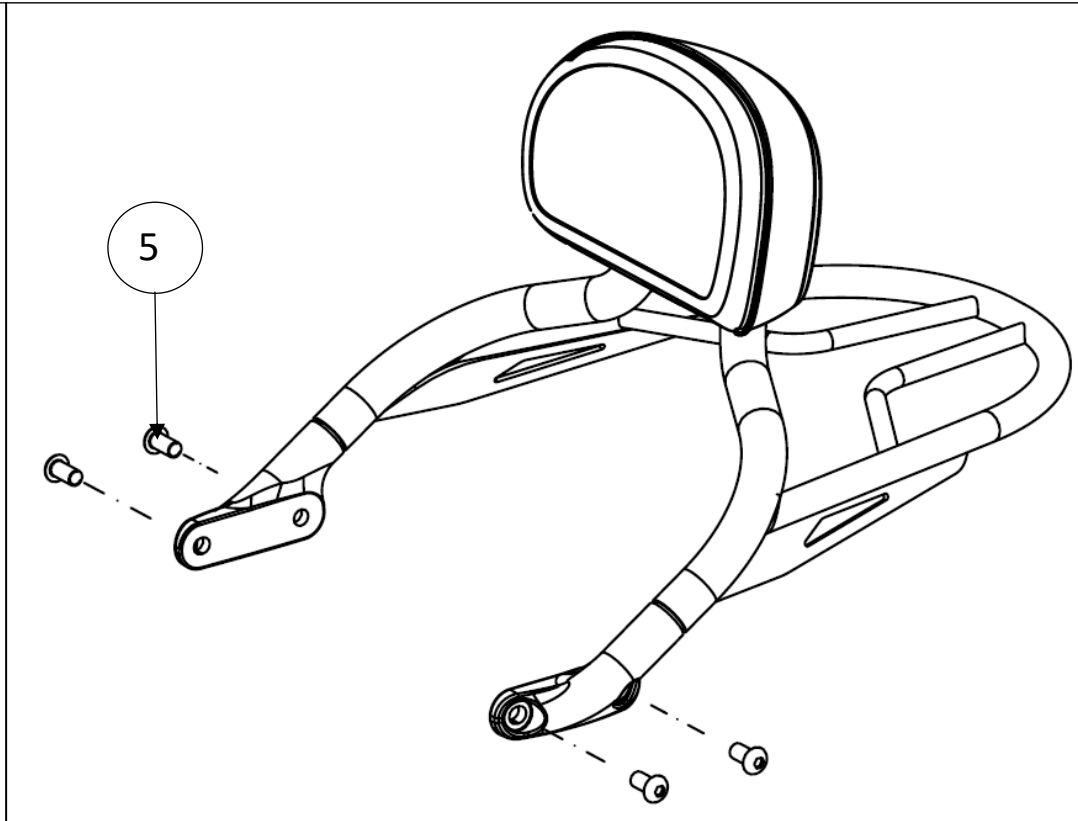
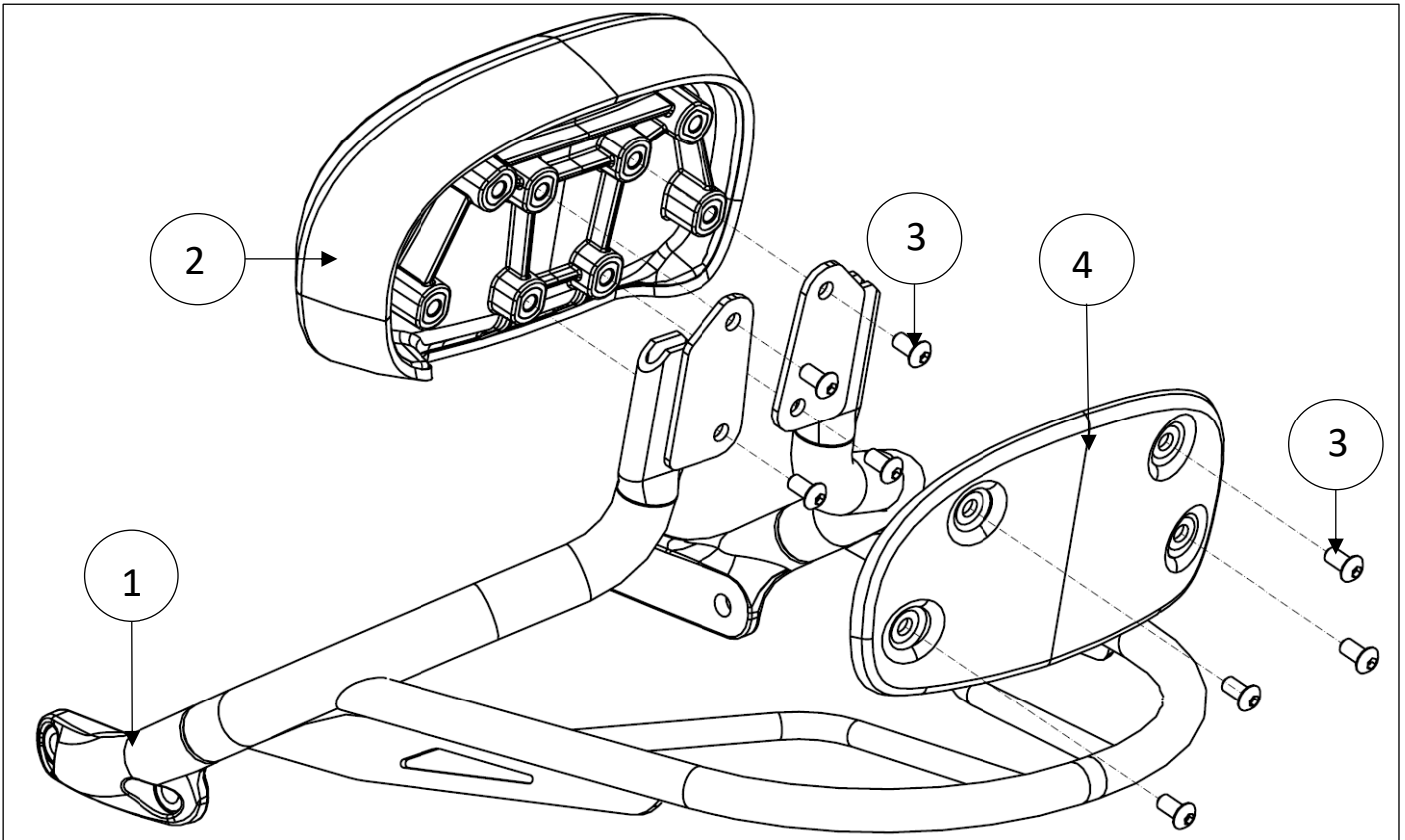

Item	Part no	Description	Qty
1	T14000B10050N	BACKREST & REAR RACK ASSY	1
2	T14000B10460N	LEGACY BACKREST FOAM ASSEMBLY	1
3	SF0212018	SCREW RDSKT M6X1X12XA2-70	8
4	T14000B10440N	BACKREST COVER	1
5	SF0212025	SCREW RDSKT M8X1.25X16XA2-70	4

Fitment Sequence:

* **Rear Rail (P/N T14000B10470N) (A)** must be installed **Before** installation of **Backrest with rack**.

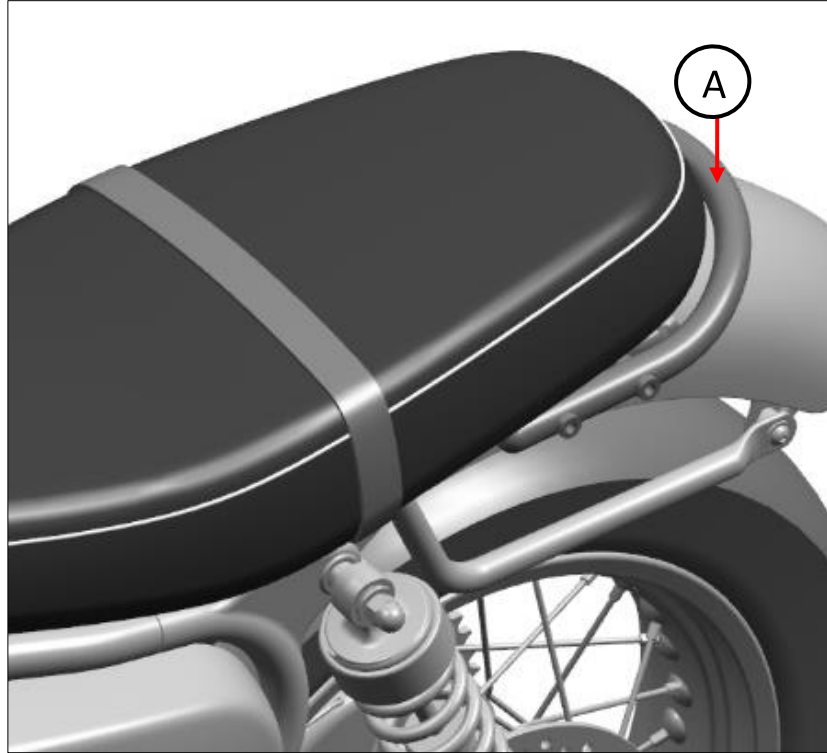

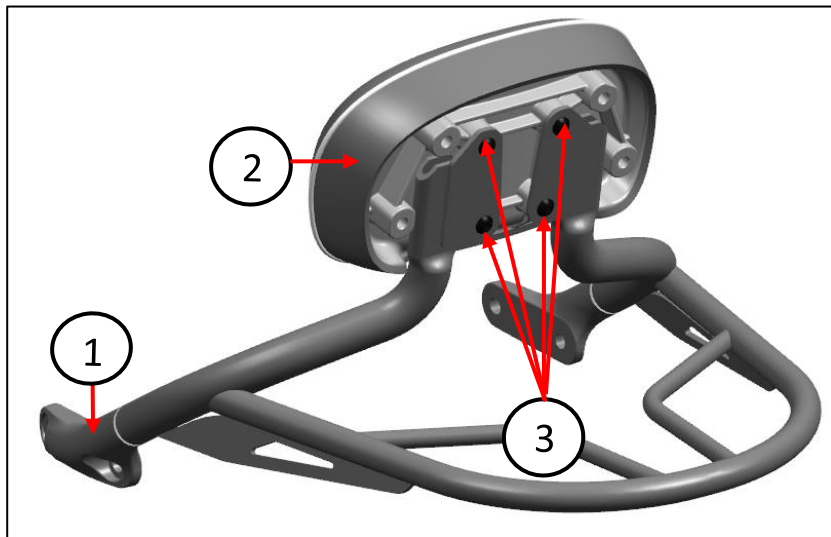

1. Assemble foam assembly (1) on backrest with rack assembly (1) by using four M6 x12 screw (3)

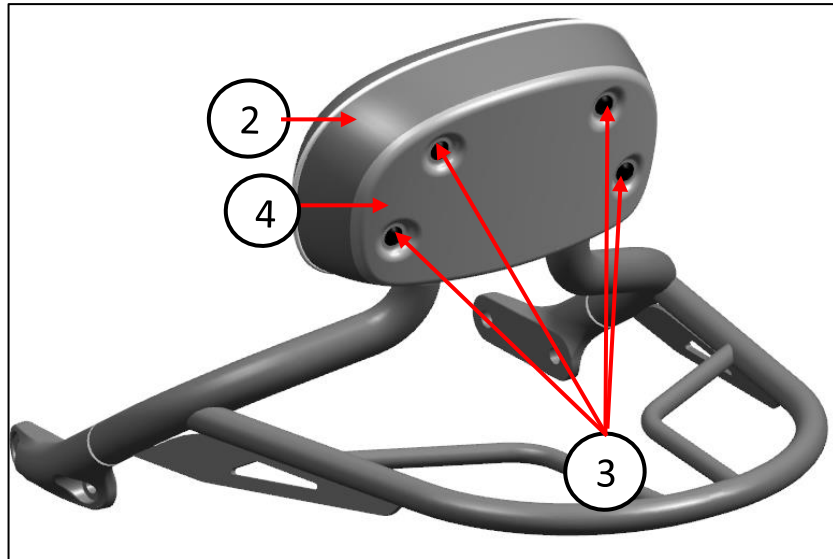

	4 mm hexagonal bit & Ratchet
	Tighten the bolt to 12 Nm

2. Assemble backrest cover (4) on foam assembly (2) by using four M6 x12 screw (3)



	4 mm hexagonal bit & Ratchet
	Tighten the bolt to 12 Nm

3. Assemble backrest assembly (1) on Rear rail by using four M8x16 screw (5)

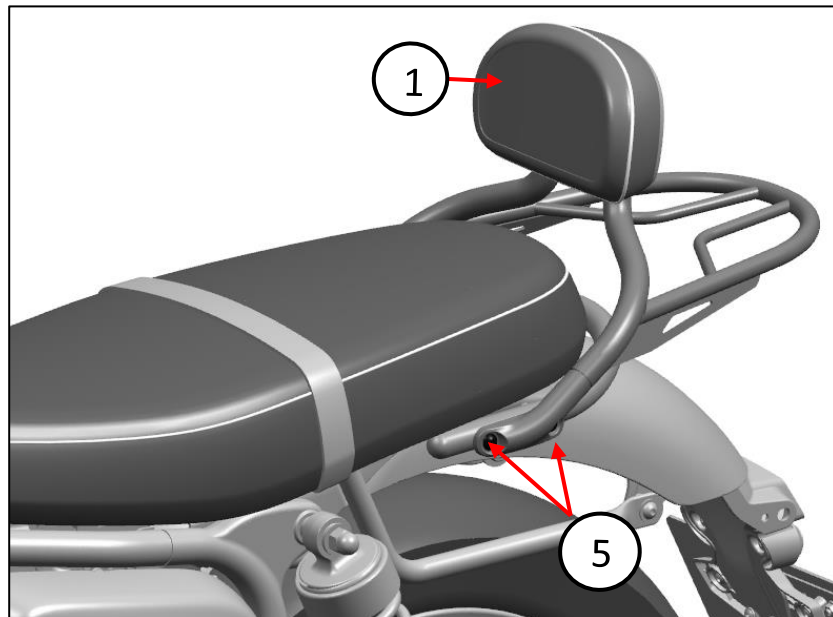

	5 mm hexagonal bit & Ratchet
	Tighten the bolt to 25 Nm

⚠ WARNING: After fitting any genuine BSA accessory always ride the motorcycle with caution and allow time to become familiar with any change in the motorcycle handling characteristics. Failure to become familiar with any change in the motorcycle handling characteristics may cause the motorcycle to become unstable and result in an accident.